

Span Enlargement of Overpasses on Widened Existing Highways

Ampliaciones de luz de pasos superiores de autopista

Álvaro Serrano Corral^a y Ginés Ladrón de Guevara Méndez^b

^a *Ingeniero de Caminos, Canales y Puertos. Technical Director. MC2 Estudio de Ingeniería (Tyspa Group). Madrid (Spain).*

^b *Ingeniero de Caminos, Canales y Puertos. Project Director. MC2 Estudio de Ingeniería (Tyspa Group). Madrid (Spain).*

Recibido el 1 de diciembre de 2020; aceptado el 16 de junio de 2021

ABSTRACT

This article presents a very versatile structural solution to the problem raised by existing overpasses on motorways which require road widening works or an increased number of traffic lanes. The proposal, consisting of the overpass span's enlargement, overcomes the difficulties imposed by the combination of works required to retain the entire deck of the overpass without demolition work while keeping both, the motorway and overpass open to traffic.

KEYWORDS: Bridge refurbishment, span enlargement, life extension, composite bridge.

© 2021 Asociación Española de Ingeniería Estructural (ACHE). Published by Cinter Divulgación Técnica S.L. All rights reserved.

RESUMEN

Este artículo presenta una solución estructural muy versátil para dar respuesta al problema que surge con los pasos superiores de autopista cuando se requiere ampliarla o incrementar su número de carriles, no habiendo sido previsto inicialmente. La propuesta, consistente en ampliar la luz del paso superior, permite resolver las dificultades impuestas por la combinación de trabajos necesarios para mantener el tablero del paso superior, evitando su demolición, a la vez que se mantiene el tráfico, tanto en el paso superior como en la autopista.

PALABRAS CLAVE: Rehabilitación de puentes, ampliación de luz, prolongación de la vida útil, puente mixto.

© 2021 Asociación Española de Ingeniería Estructural (ACHE). Publicado por Cinter Divulgación Técnica S.L. Todos los derechos reservados.

1. INTRODUCTION

The ever-increasing need of mobility over recent years has been a common denominator in the majority of industrialized and developing countries. The increase in road traffic demand is currently reflected by a proportional growth in the number of kilometres of new high-capacity motorways and an increase in the capacity and quality of existing highways.

The main problem raised by the widening of existing highways is the interference of overpass structures' piers when the original highway has not been originally designed for an expected widening. Then, the first evident solution is to demolish the overpass and to re-build a new one adapted to the widened highway; nevertheless, this solution has very high costs, not only economic, but social, considering the traffic in-

terruption on the overpass over the highway and the affection to highway, itself.

Rather than demolishing these structures and building new overpasses to suit the modified layout of the motorway, which, as said, is always a very traumatic procedure, the method presented here simply considers the replacement of the existing foundations and piers by different elements which are perfectly compatible with the new road requirements. This solution has the additional advantage that it does not affect road traffic in any way and maintains the existing overpass decks without requiring any type of reinforcement or modification.

All types of solutions of wide-ranging characteristics have been employed throughout the world to overcome the problem. Solutions ranging from the replacement of the original overpass by a new one to that of taking full advantage of the

* Persona de contacto / Corresponding author.
Correo-e / email: alvaro.serrano@mc2.es (Álvaro Serrano)



Figure 1. First overpass span enlargements in AP-7 highway (Section: El Vendrel - Salou). 1997. Typological variations.

horizontal clearance below the existing, untouched structure. The solution given in this presentation arises from a global overview of the problem and allows maximum traffic flow both during and after the work while providing highly interesting and original structural results.

The solution was conceived by Julio Martínez Calzón in the late 90's and applied firstly in 14 overpasses in the AP-7 highway in Catalonia (figure 1). Later, more than 50 overpass span enlargements in different Spanish highways with different typologies have been developed¹, with further evolution of the system.

The solution has been satisfactorily applied to both, road and rail overpasses built in prestressed and/or reinforced concrete with three or four spans and with central spans in the region of 30 metres and provide an increased clearance between 3 and 10 metres.

In general terms, the system consists of connecting steel or composite elements parallel to the concrete deck by means

of transversal prestressing. These parallel structural elements, then, serve to transfer the reactions acting on the old piers down to the new foundations located in a new position in order to provide the required increase in clearance width.

The proposed solution also has a notable effect on the appearance of the overpass and, subsequently, satisfies all working requirements: ease of construction, low public cost, structural quality and aesthetics.

2.

GENERAL DESCRIPTION OF THE STRUCTURAL SYSTEM

The structural arrangement of the system is based on two basic design principles:

- No hindrance to highway and overpass operation.
- Retaining practically constant forces on the existing deck

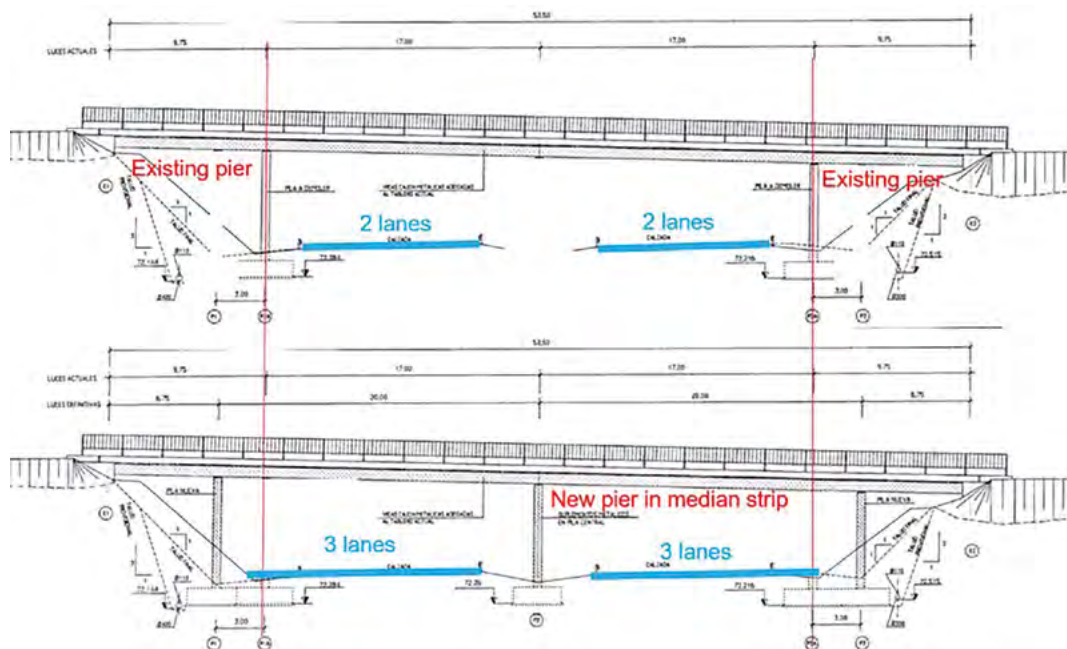

Figure 2. Layout for overpass enlargement with new pier in the median strip of the highway.

¹ All these overpass span enlargements have been developed by MC2 Estudio de Ingeniería.

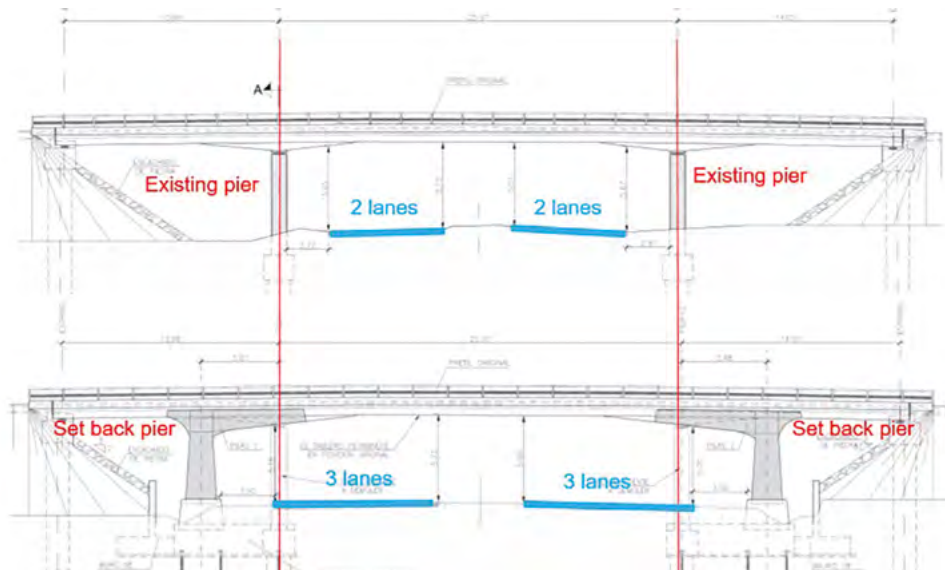

Figure 3. Layout for overpass enlargement without pier in the median strip.

and completely maintaining the strength and operational capacity of the existing structure.

Depending on the initial condition of the overpass, two types can be differentiated:

- Overpass with three spans, short lateral spans and a new pier in the median strip of the highway.
- Overpass with three spans, without pier in the median strip of the highway.

2.1. *Span enlargement with pier in the median strip of the highway*

This solution is adequate when the overpass has short lateral spans, and it is not problematic to build a new pier in the median. The schematic layout for the solutions is shown in the [figure 2](#).

2.2. *Span enlargement without pier in the median strip of the highway*

The aforementioned solution has the inconvenience that a

new pier in the median strip of the highway is needed. This involves works in that zone in quite uncomfortable conditions, if the strip is narrow.

In order to improve the design, an evolution of the prior type has been developed, avoiding this intermediate pier, as explained in [figure 3](#).

This structural layout is easier to implement if the overpass has lateral spans which are well balanced with the original central span.

[Figure 4](#) shows the initial and final elevations of a purpose-built solution. The increase in effective clearance of the highway using this method ranges between 20% and 40% of the original central span of the overpass. The concepts, elements and procedures involved in the solution are described below in accordance with the pre-established geometrical requirements imposed by the maintenance of traffic flow.

The process essentially consists of introducing new steel or composite support elements below the lateral cantilevers of the reinforced or prestressed concrete slabs forming the deck. These new support elements are perfectly shaped to suit the soffit of the overpass ([figures 5 and 6](#)). The rhomboidal upper

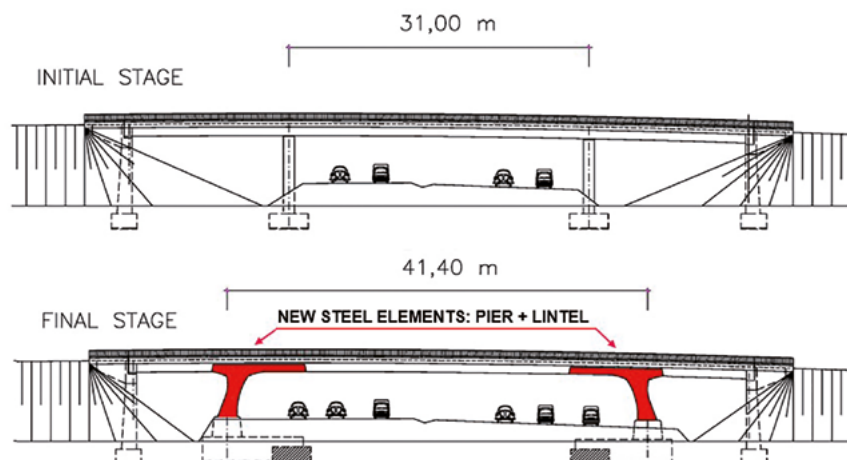

Figure 4. Initial and final situations of the overpass. Elevation.

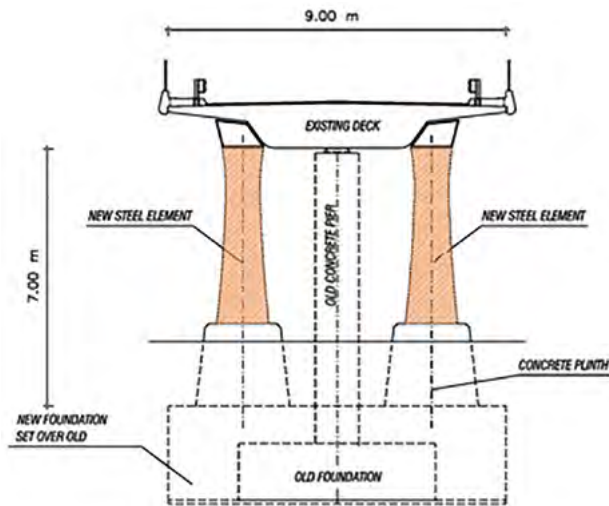

Figure 5. Initial and final situations of the bridge. Cross-section.

section of these new support elements, henceforth referred to as the "steel lintels", takes the loads from the deck at the location of the old piers and transfers them back to the new ones.

These steel lintels are connected to the concrete deck by means of transversal prestressing permitting transfer of the vertical actions from the deck through the contact interface between deck and lintel (figure 6). The said connection is a highly interesting element from a structural point of view, both in terms of the technology of the component parts as well as the original execution procedure. This procedure is essential in order to retain an unchanged force in the existing deck and assuring maximum collaboration of the deck and lintels. The elements and procedure involved in the said connection will be described in more detail further on.

The shaft or the lower vertical section of the new support is set on the new axis of support in order to provide the required highway clearance. The shaft may be steel or composite depending on the type of section selected and the prevailing conditions of each case. The bottom of the shaft is supported on a concrete plinth to ensure that the steel remains clear of the ground. This concrete plinth also serves to enhance the general appearance of the new solution.

The forces transferred by the steel or composite shafts down to the concrete plinth supports then have to be transferred to the new foundations: These new foundations frequently occupy part of the area of the old foundations. However, these original footings cannot be removed as they are still load bearing at this stage of the process. Hence, the existing footings are used to work in collaboration with the new foundation. The old and new foundations are suitably tied together by means of passive steel bars.

3. TRANSVERSAL PRESTRESSING OF THE DECK- STEEL LINTEL CONNECTION AND DEAD LOAD TRANSFER OPERATION

The existing concrete deck structure and the new pair of steel lintels are connected by means of a system of high strength steel

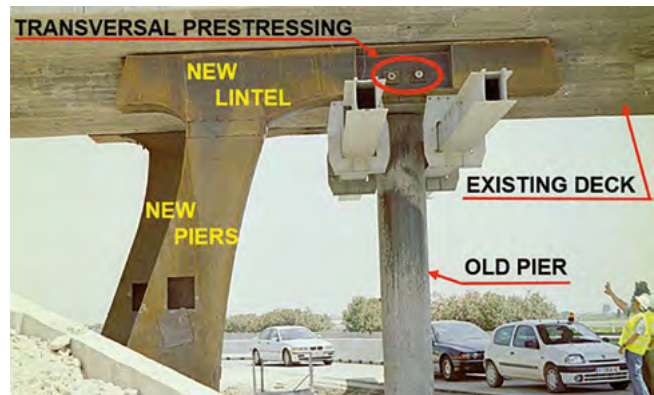

Figure 6. Construction stage prior to the removal of the old concrete pier and load transfer to the new steel lintel and pier.

bars running transversally through both elements. In this way the vertical movements of the steel lintels and the concrete slab are identical at the connection points which are set in the axis of the original piers. Hence, the new support for the concrete deck slab, by means of these steel lintels is at the original position of the pier, but its load is transferred to the new set back shafts. Figure 7 shows the two construction stages for the transverse deck-steel lintel connection. Figure 7 (top) shows the drilling of the concrete deck in order to accommodate the steel bars. Figure 7 (bottom) shows the placing of the jack for prestressing the bars.

Due to the slenderness of the steel lintels, in order to maintain the existing vertical clearance levels above the highway, the old piers could not be simply removed by transferring the existing actions at the said points from the slab to the lintels, since in this case the deflection of the steel lintels would lead to unacceptable forces in the existing concrete deck. Instead, the said load transfer from the pier to be re-



Figure 7. Drilling of deck (top) and tensioning of prestressing bars (bottom).



Figure 8. Steel lintel-shaft after transfer operation of dead load.

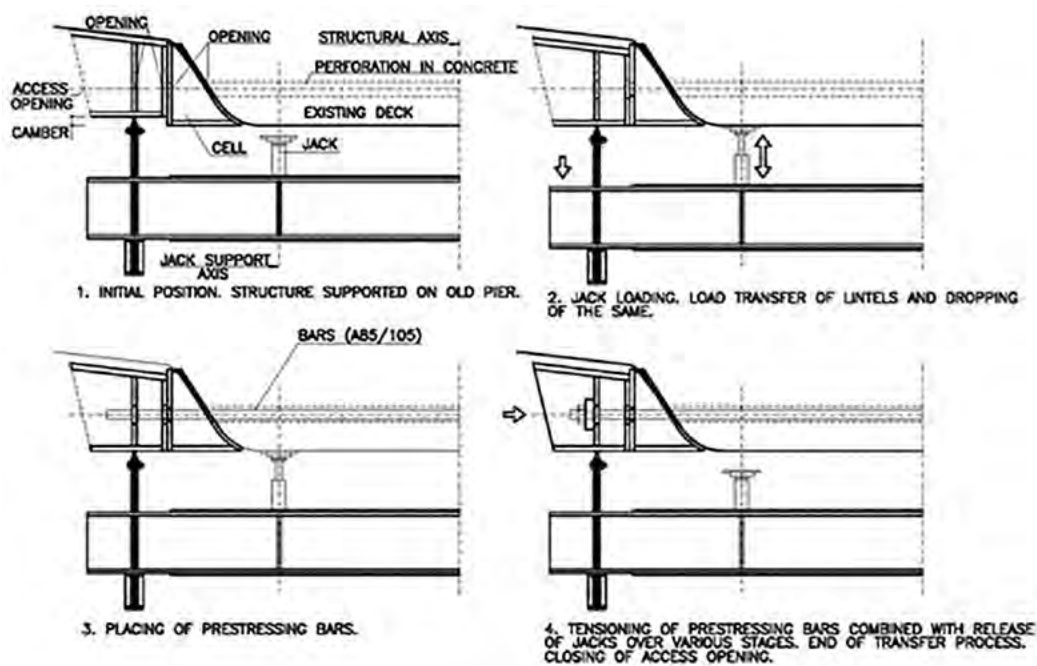

Figure 9. Dead load transfer operation.

moved to the new steel lintels is made, while the existing level of the concrete deck at these points is maintained by active jacking.

A system of hydraulic jacks is set between the deck and the pier-steel lintels, as close as possible to the existing piers, prior to the connection of the lintels to the slab (figure 8). As the jacks are loaded the steel systems gradually deform and reduce the reaction of the concrete slab on the existing pier, transferring it to the steel lintel. Once the value of the deck reaction is reached by the jacking system, the jacking is stopped immediately prior to the point where the deck would begin to rise.

At this point and with the jacks blocked, it is then possible to activate the connection between the steel lintel and the deck by means of the transversal bars described above without producing the slightest movement in the deck. As there are no new movements in the concrete structure there is no variation whatsoever in the deck forces due to dead loads, i.e. these loads remain the same.

These loads remaining the same as at the start of the operation.

At this moment, the existing pier is totally unloaded, its load transferred to the lintels and can be removed. The new piers are installed with a precamber which is compensating the strain occurring during the load transfer operation leaving the concrete deck and steel lintels at the same level.

Another element of key importance is the “cell” (figure 9). This cell provides a vertical interface between the surface of the concrete deck and that of the steel lintel, permitting relative vertical movement during the load transfer operation.

After this transfer, the live loads acting on the existing deck and new steel lintels system will lead to slight settlement at the support points of the old piers. These movements will inevitably cause slight variations in the maximum internal forces at the critical sections. However, because of the moderate variation (usually less than 5%), the increased effects are perfectly resisted by the original concrete deck due to the increased strength resulting



Figure 10. Overpass span enlargement load test.



Figure 11. Overpass on the AP-7 highway near El Vendrell.



Figure 12. General view of a structure on the A-7 highway in the Valencia By-Pass.



Figure 13. Overpass in the A-30 highway in Murcia. Span enlargement solution with half-lap joint in the deck.



Figure 14. Asymmetric span enlargement in the AP-9 (Pontevedra).

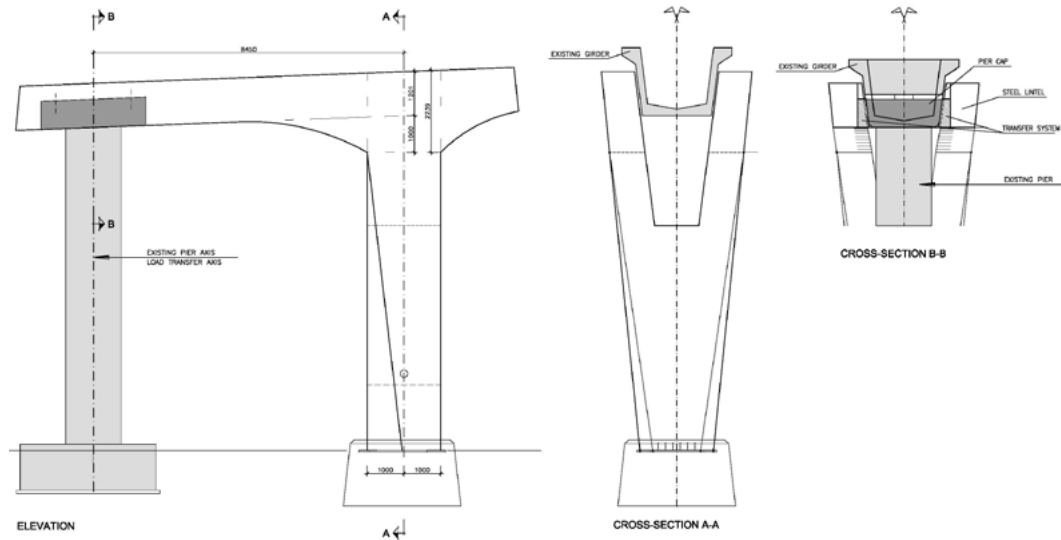

Figure 15. Steel shaft and lintel for precast deck in the A-54 /AP-9 intersection.

from ageing and as a result of the reserve capacity provided by the existing prestressing systems in the deck.

Finally, to check the adequate structural behaviour of the span enlargement, a load test is carried out (figure 10). This is the only moment in which the traffic along the overpass is interrupted. During the load test, the old pier is still in place but without contact to the deck, in order to have a fail-safe system in case any kind of problem would arise. This old pier is later demolished.

4. SUMMARY OF WORKS CARRIED OUT AND TYPOLOGICAL VARIATIONS

The general methodology described in this article has been applied on numerous occasions in Spain with very satisfactory results². The majority of these span enlargements have already been completed while others are still underway. The following is a brief listing of these works.

- 14 overpasses on the AP-7 highway between Barcelona and the French border. This system consisted of continuous steel lintels set throughout the length of the deck and simply supported on the new supplementary composite piers in the median strip [1].
- 2 overpasses on the AP-7 highway between El Vendrell and Salou built in 1997 and of a similar design to that indicated above (figure 11).
- 1 overpass on the Rande-Puxeiros section of the AP-9 Atlantic Highway built in 1998 and of a similar design to the preceding types, including a new central pier on the central median strip of the highway which did not exist in the original structure.
- 8 overpasses for the 3-lane road widening works on the AP-7 highway in Tarragona.
- 21 overpasses on the A-7 highway in Valencia By-Pass. Work completed in February 2002. The solution applied here does

not substantially differ from the preceding works though the alternatives do present certain innovations. There was no existing central pier, and it was not possible to build a new one at the median strip. In this case, the steel lintels and piers were arranged with an embedded connection in the form of a cantilever, with the entire assembly being shaped in the form of a "T" or "Γ" (figure 12) which directly transfers the forces from the deck down to the foundations [2,3].

- 2 overpasses on the A-8 highway between Bilbao and Behobia. In this case the selected alternative corresponds to that described for the preceding works with their "T" shapes, though with certain variations in terms of appearance.
- 1 overpass on the A-8 highway in the Orío – Usurbil section, using the same "T" typology.
- 1 overpass in the A-30 Highway in Murcia. In this case, a "Γ" steel shaft was designed. The main characteristic of this work is that the existing overpass does not have a continuous deck slab, but a deck composed of concrete T beams simply supported on half-joints. In this case, the connection between the existing deck and the steel lintel is done in the transversal diaphragm at the location of the existing piers (figure 13).
- 1 overpass in the A-30 Highway between Murcia and Cartagena quite similar to the Valencia By-Pass span enlargements.
- 1 overpass in the AP-9 highway in Pontevedra near Curro. In this case a "Γ" solution is adopted, but only eliminating one of the existing piers allowing to build a deceleration lane, constituting an asymmetric solution (figure 14).
- 1 viaduct span enlargement. In this case, the span enlargement is not done on an overpass, but in a long highway viaduct in the A-54 highway over the AP-9 highway near Santiago de Compostela, in order to increase the capacity in the AP-9 highway. The viaduct has a precast concrete deck composed of twin box girders. The novelty is that the connection is not done on the deck but on the pier cap at the top of the pier. The steel lintel and shaft have a singular form to adapt to the viaduct deck geometry (figure 15). The works are expected to start in 2021.

² These projects have been developed by MC2 Estudio de Ingeniería.

- 14 overpasses on the A-7 Highway in Alicante, near Crevillente, using the "T" typology.
- 2 overpasses on the A-7 Highway in Murcia, near Orihuela, using the "T" typology.

The latest projects are designed using the "T" and "Γ" typology and works are expected to start on 2021-2022.

All these alternatives form just a small part of the many possibilities offered by the system. A wide variety of structural forms can be designed on the basis of the original concept and each form has to be analysed in accordance with the geometrical and load conditions of the existing overpass.

5. EXTENSION OF THE METHODOLOGY

This methodology is based on structural principles that can be applied to many other problems that involve change in the support conditions of a structure. A typical application of the methodology is the removal of supports in buildings due to new functional requirements. Removing a support in a building involves the need of maintaining the floor level over the support to be removed in the same way as described for the overpass deck.

The following example is given for illustration. To allow the reorganization of high-speed railway tracks in the entrance to the Sants Railway Station in Barcelona, removal of supports with a dead load of 12000 kN and live load of 10000 kN was required. In order to provide a new support section, composite truss lintels with a mean main span of 16 m were designed and a load transfer at the existing support section was carried out (figure 16) [4].

6. CONCLUSIONS

The most relevant aspects of the system may be summarized as follows:

- The most relevant aspect is the practical lack of interference to overpass and highway traffic. When this factor is considered in global economic terms it more than emphasises the highly competitive level of these solutions for the spans, extensions and structural types considered.
- Ease of work at all stages of the construction process: footings, deck perforations, placing of cells, positioning of new piers, transfer of dead load and the application of transversal prestressing.
- Very short execution periods with a high level of standardization. This allows an "assembly line" extension of a large number of structures of similar characteristics in very competitive periods. The working area required for these extension works is also very much reduced.
- With regards to the structure, it should be underlined that the force and strain state of the deck remains unchanged throughout the load transfer process. Slight variations in forces only occur during the subsequent application of



Figure 16. Composite trusses to support removal in Sants Railway Station in Barcelona.

live loads, although these variations are low and generally negligible (less than 5%).

- The solutions presented demonstrate the high versatility of the system, offering a broad range of geometric possibilities to suit dimensions and shapes of many types of overpasses and other structures. The system thereby offers maximum structural and geometric compatibility with the existing structure. The combination of steel and concrete elements provides a particularly attractive effect, mainly due to the interaction of colours of the concrete and of the weathering steel. However, it is equally possible to employ painted steel surfaces.

Acknowledgment

With this article, we would like to express our recognition and appreciation to Luis Ortega Basagoiti, excellent engineer and excellent friend, prematurely passed away.

References

- [1] Martínez Calzón, J. (1997) *Rehabilitation and Repairs of Structures Using Composite System*. International Conference: Composite Construction – Conventional and Innovative. Innsbruck, Austria. 101-112. <https://doi.org/10.5169/seals-954>
- [2] Martínez Calzón, J., Ladrón de Guevara Méndez, G. (2002) *Ampliaciones de luces de pasos superiores de autopistas existentes. Solución aplicada en la autopista A-7 (By-Pass)* Valencia. II Congreso de ACHE de puentes y estructuras de edificación. Madrid, Spain 2002.
- [3] Ladrón de Guevara Méndez, G., Martínez Calzón, J. (2002) *Span enlargement of overpasses on existing motorways*. IABSE Symposium Melbourne 2002: Towards a Better Built Environment – Innovation, Sustainability, Information Technology. Melbourne, Australia 2002. 36-42. <https://doi.org/10.2749/222137802796336108>
- [4] Martínez Calzón, J., Ceriani, L. (2008) *Estación de Sants en Barcelona. Grandes dinteles de apeo para la eliminación de soportes entre vías*. IV Congreso de ACHE de puentes y estructuras de edificación. Valencia, Spain.