

# Birth, development and future of the extradosed bridge

## *Nacimiento, desarrollo y futuro de los puentes extradosados*

Akio Kasuga<sup>a</sup>

<sup>a</sup> Ph.D. Chief Technology Officer. Technical Director. Sumimoto Mitsui construction. (Tokyo, Japan).

Recibido el 22 de junio de 2018, aceptado el 24 de octubre de 2019

### ABSTRACT

The extradosed bridge idea dates back to 1988, when Mathivat presented the concept. Since then, this structural type has been used worldwide. The first extradosed bridge was the Odawara Blueway Bridge completed in Japan in 1994. Although the principle was originated in France, it is fair to say that the bridge would not have spread, so far and so quickly around the world, without Japan's efforts to put the principle into practice. In this paper, the progress of the extradosed bridge from its birth to the today state of the art is analysed. Finally some thoughts on the future trends on design of this structural type are presented.

© 2019 Asociación Española de Ingeniería Estructural (ACHE). Published by Cinter Divulgación Técnica S.L.L. All rights reserved.

KEYWORDS: Extradosed bridge, butterfly web, multi-span bridge, hybrid bridge, cable anchorage.

### RESUMEN

El primer concepto de puente extradosado fue presentado por Mathivat en 1988. Desde entonces este tipo estructural se ha construido por todo el mundo, siendo su primera realización el Puente Odawara Blueway terminado en Japón en 1994. Aunque la idea original surge en Francia, es justo decir que el desarrollo y la construcción de los puentes extradosados no habría llegado tan lejos y tan rápidamente sin los esfuerzos de Japón para poner en práctica el principio. En este artículo, se describe el progreso de los puentes extradosados desde su nacimiento hasta el estado actual de su técnica, así como una reflexión sobre las futuras tendencias del proyecto de este tipo estructural.

© 2019 Asociación Española de Ingeniería Estructural (ACHE). Publicado por Cinter Divulgación Técnica S.L.L. Todos los derechos reservados.

PALABRAS CLAVE: Puente extradosado, alma en mariposa, puente multivano, puente híbrido, anclaje de cables.

## 1. INTRODUCTION

The world's first extradosed bridge, the Odawara Blueway Bridge (Figure 1), was completed in 1994, and I had the honor of working on its design and construction. In the twenty-something years since then, I have remained involved with extradosed bridges, including giving keynote speeches at international conferences, serving on conference committees, writing articles, and contributing to books. All in all, about half of my career as a bridge engineer has been intertwined with the advance of the extradosed bridge. That has given me

a privileged view of the birth and development of this new structural form.

The extradosed bridge dates back to 1988, when Mathivat [1] first laid open his ideas, and has since spread worldwide, beginning with the Odawara Blueway Bridge. Although the principle originated in France, it is fair to say that the bridge would not have spread so far and so quickly around the world without Japan's efforts to put the principle into practice. The first extradosed bridge to be completed in France was the Saint-Remy-de-Maurienne Bridge over the A43 (1997). An extradosed bridge has since been constructed in French territo-

\* Persona de contacto / Corresponding author.  
Correo electrónico: Akio Kasuga: [Aakasuga@smcon.co.jp](mailto:Aakasuga@smcon.co.jp)



Figure 1. Odawara Blueway Bridge



Figure 2. Saddle anchorage of extradosed cables

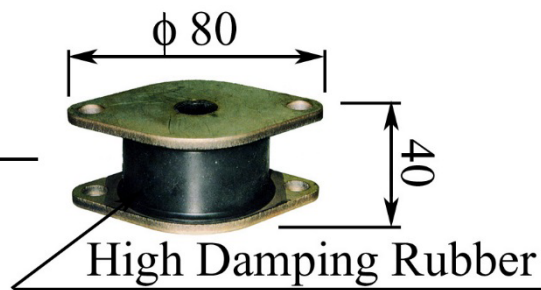
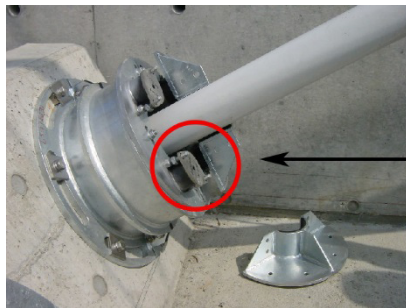

Figure 3. High damping rubber damper

ry on Réunion Island, but there are still no full-scale examples in mainland France.

When Mathivat's ideas first appeared in FIP Notes, Japanese readers paid little attention to them, seeing them as little different from the cable-stayed bridges that were already in service. Nevertheless, when construction of the Odawara Blueway Bridge commenced, the site proved a constant attraction to engineers, receiving over 3,000 visits in total. Considered in the context of the subsequent development of extradosed bridges, this represents a tribute to the expressway company for its bold decision to adopt an extradosed bridge design for the Odawara Blueway Bridge. In this paper, I would like to outline the progress of the extradosed bridge from birth to development, and present my views regarding directions for further development.

## 2. ODAWARA BLUEWAY BRIDGE

Designing the world's first extradosed bridge, the Odawara Blueway Bridge, involved tackling a host of difficult issues. The first challenge was the design of the saddle for the cables on the pylons, which was being used for the first time on a concrete bridge. Detail design had to find a solution for securing the cables that could cope with a difference in tension on either side of the pylon in an earthquake. Secondly, the struc-

tural grounds behind adopting an allowable stress of  $0.6f_{pu}$  for the cables had to be demonstrated. That meant clarifying how the cables differed from those of cable-stayed bridges, which were designed with a maximum stress of  $0.4f_{pu}$ . Thirdly, there was the challenge of having to control vibration in the cables, because lowering the safety factor for the cables reduced their fatigue strength. To achieve that, a new cable damping system had to be developed.

The key point of the saddle design was the detail design that took replacement of cables into account. By making the holes in the saddle keyhole-shaped, a cable being replaced could be shifted to one side so as not to interfere with the new cable. Also, we used on-site fabrication for the body of the anchorage that keeps the saddles in place in an earthquake, and devised a solution for securing the cables by wedging a bifurcated taper plate between the anchor and the pylon (Figure 2). We then verified the appropriateness of this new anchor structure by testing it with full-size models [2]. At the time, there were no saddle systems like this anywhere in the world, so we had to develop the technology from scratch with no examples for reference.

For the cable damping system, the systems in use at the time were either viscous dampers or oil dampers. I was working on this issue, and attempting to find a way to utilize high-damping rubber, which involved the rapid development of a high-damping rubber damper. After establishing a design methodology [3], a high-damping rubber damper that was sufficiently compact to fit inside the cable end was designed

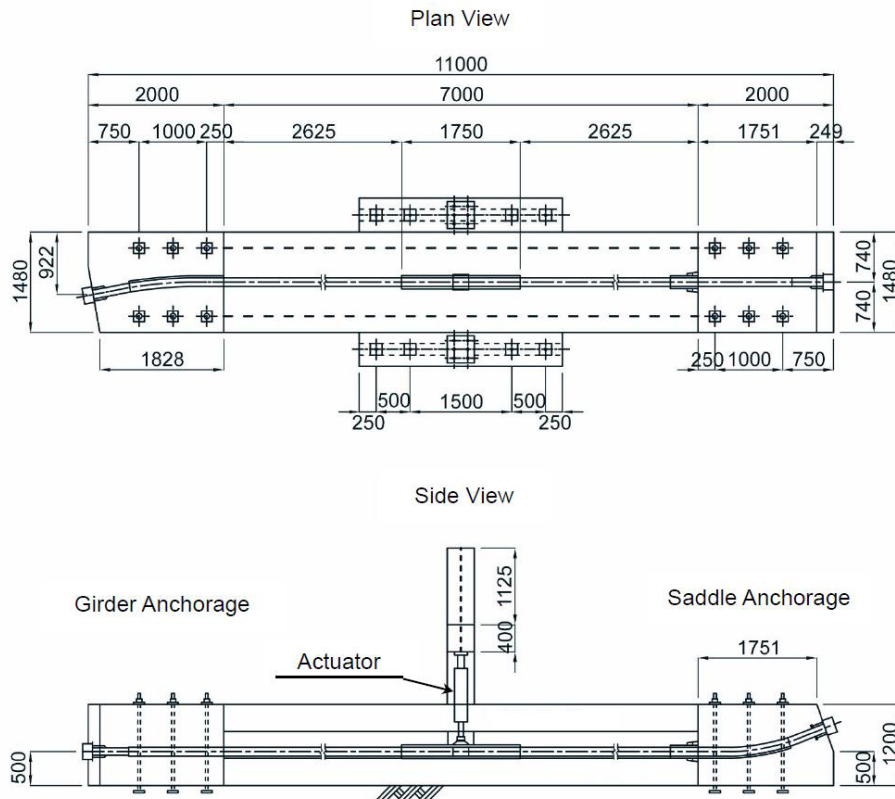

Figure 4. Cable bending fatigue test setup

(Figure 3). The Odawara Blueway Bridge adopts the premise of using a damping system to damp vibration of the cables, and because the cables are bent when anchored at both the saddle and deck anchorage, design had to take into account fatigue within the allowable range of vibration amplitude. We used the cable bending fatigue test [4] shown in Figure 4, which was probably the first time such a test had been performed. Once the cables start to vibrate, they reach 2 million oscillations in a very short time. Consequently, we considered that dangerous vibrations could be avoided by managing the fatigue limit, or in other words, by clarifying and managing the allowable amplitude. In a major inspection of the cables after 14 years in service, neither the cables nor the rubber dampers showed any signs of potentially problematic symptoms.

### 3. CABLE ANCHORAGE STRUCTURES ON PYLONS

Following Mathivat's proposals, saddles were used on the first extradosed bridges. However, news reached Japan of fatigue tests on cable-stay bridge saddles in the US revealing strand fracture issues. The problem appeared to be due to fretting fatigue resulting from very small relative movements causing bare strands to rub against one another. We promptly conducted fretting fatigue tests [5], and set an upper limit, 50 N/mm<sup>2</sup>, for variations of cable tension in the saddle (Figure 5). This has

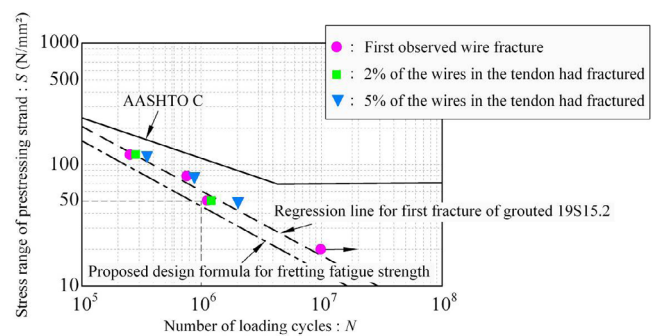

Figure 5. Fretting fatigue test results

been incorporated into Japan Prestressed Concrete Institute (JPCI) standards [6]. The tests were performed on uncoated strands, so a higher limit applies to epoxy-coated strands, which have greater resistance to fretting fatigue. The research concerning strand fretting fatigue, like that concerning cable bending fatigue, was a world first.

In fretting fatigue, the fatigue characteristics are greatly influenced by the contact pressure, which varies according to the number of overlapping layers of strands bent at the saddle. At the time, the only saddle systems available in Japan were for 19S15 or 27S15 cables, which have 19 or 27 strands, and that was a significant constraint on extradosed bridge design. Also, the studies on fretting fatigue had only covered cables with up



Figure 6. Ibigawa Bridge



Figure 8. Shimmeisei Bridge

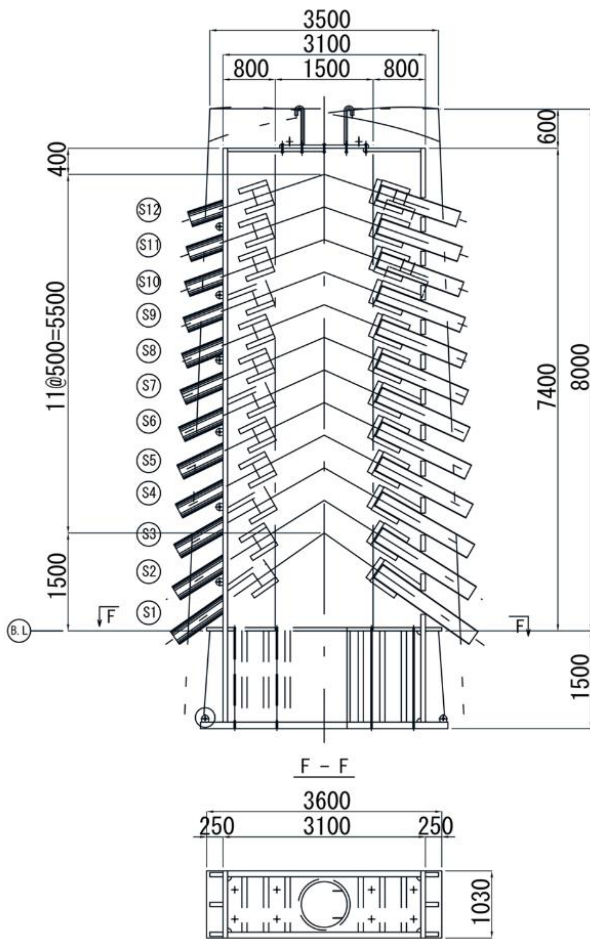

Figure 7. Steel anchorage box of extradosed cables

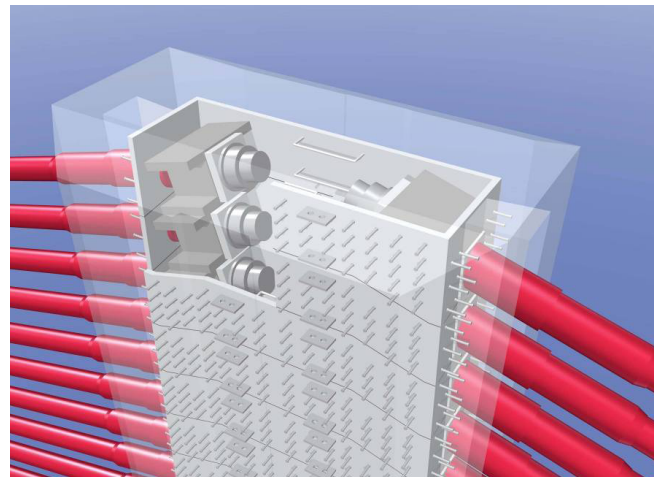

Figure 9. Composite extradosed cable anchorage system

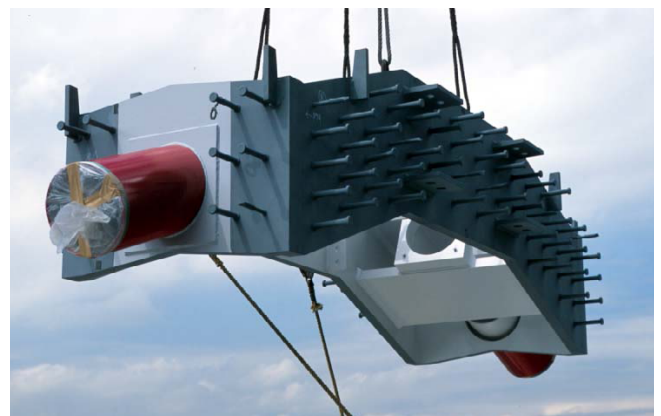

Figure 10. Separated steel box anchorage

to 27 strands, so if wanted to use cables with more strands, we would have had to conduct a new set of fretting fatigue tests. Consequently, we had reached the limit of what was feasible with the saddles that were available.

In the Ibigawa Bridge (Figure 6), the design called for factory-made cables using wires, so a saddle was not an option.

From that point, steel box structures (Figure 7) became available as an alternative to saddles for anchoring the cables on the pylons. Later, for the Shimmeisai Bridge (Figure 8), we used steel boxes because the capacity of the extradosed cables exceeded 27S15, ruling out saddles. This brought the problem of the overall steel box structure being too heavy. For the Ibi

River Bridge, we had been able to use a large floating crane for erection, but here we had to find a land-based solution. Eventually, we designed a structure with separate steel boxes for individual cables and stacked the boxes without welding or bolting them together before integrating the structure with concrete (Figures 9 and 10). Setting the tolerance for the gap between the metal surfaces of the boxes to 0.5 mm, this creates a composite structure in which the concrete carries the full load of the vertical component of the cable forces, while the horizontal components is borne by the steel plates. The intervening concrete is not placed until after the overdosed cables are completed, so none of the horizontal components of the forces acts on the concrete.

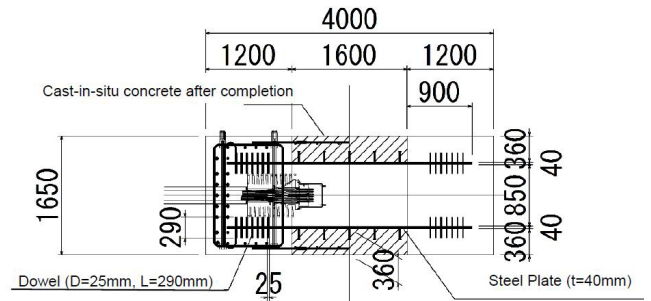

Figure 13. New composite cable anchorage system

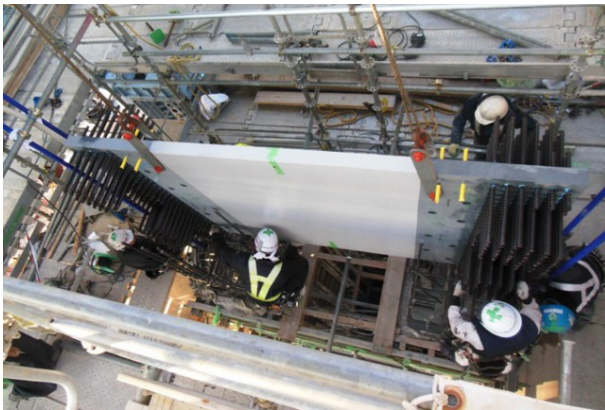

Figure 11. Single steel plate type



Figure 14. DSI system



Figure 12. Extradosed cable anchorage with single plate of Mukogawa Bridge

If a bridge requires narrow pylons, making it difficult to use a steel box structure, an anchorage structure based on a single steel plate (Figure 11) can be used, as in the Mukogawa Bridge (Figure 12). The steel plate is fabricated with holes for dowel reinforcements, producing a simple structure that needs no welding at all, enabling a reduction in cost. To further reduce



Figure 15. Nonthaburi Bridge (Thailand)

costs, it is possible to use a composite structure with a concrete anchorage beam as shown in Figure 13. This structure has already been tested and verified, and is now ready for practical application.

Major enhancements were made to saddle designs after the issue of fretting fatigue arose, and saddle systems have now been developed that can handle large-capacity cables. Figure 14 shows an example with built-up steel sections in the saddle. With this German system, the cables are anchored directly to the steel, which completely eliminates fretting fatigue in the cables [7]. The main disadvantage of this sort of design is that the anchorages are exposed, so care is required with aesthetic and rust-protection considerations. We used this saddle system for the Nonthaburi Bridge (Figure 15), the first extradosed bridge in Thailand.

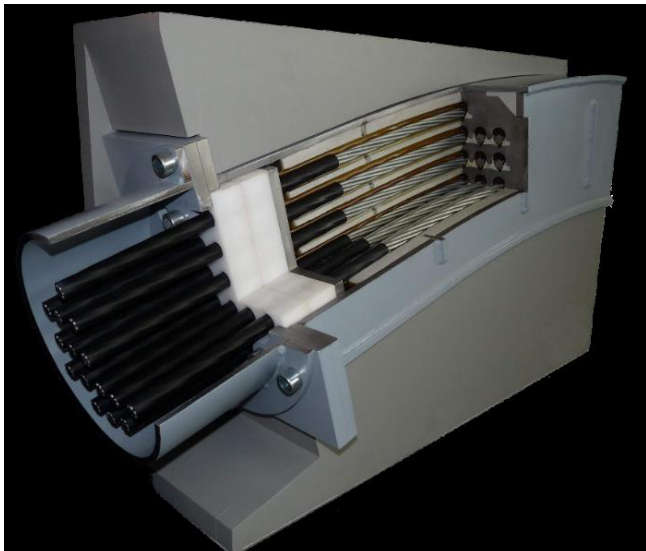

Figure 16. VSL system

Another approach is to avoid bundling strands together, instead arranging each strand independently to minimize fretting fatigue. Figure 16 shows a typical Swiss system of this type [8]. It has undergone large-scale fatigue testing at the Technical University of Berlin [9], and uses teardrop-shaped holes to ensure that the strands are securely retained, enhancing frictional forces. For countries in seismic zones like Japan, there is the question of the extent to which that friction could be relied upon, and consideration would also have to be given to the issue of how to achieve consistency during construction.

Personally, based on maintenance and cost considerations, I prefer anchorage structures to saddle systems on the pylons. And when constructing bridges in a seismic zone, it is always important to gain a full understanding of the seismic performance of any systems or components originally designed for use in areas with few concerns regarding earthquakes. The Odawara Blueway Bridge project was the first in the world to develop a saddle for a full-scale concrete bridge. The expertise accumulated on that project has been of great help in the further development of saddle systems. And now there is also much more variation in the anchorage structures that can be used for anchoring extradosed cables to pylons, providing bridge engineers with broader of options.

#### 4. THE DIFFERENCE BETWEEN EXTRADOSED AND CABLE-STAYED BRIDGES

Ever since the Odawara Blueway Bridge project, I have frequently been asked how an extradosed bridge differs from a cable-stayed bridge. Mathivat's proposal only explained that he was using the same factor of safety as for regular external cables of the relatively small influence of fatigue. That is reasonable, but it leaves open the questions of what the limits are, and under what conditions  $0.6f_{pu}$  can be used. Finding the answers required a substantial investment of time and effort.

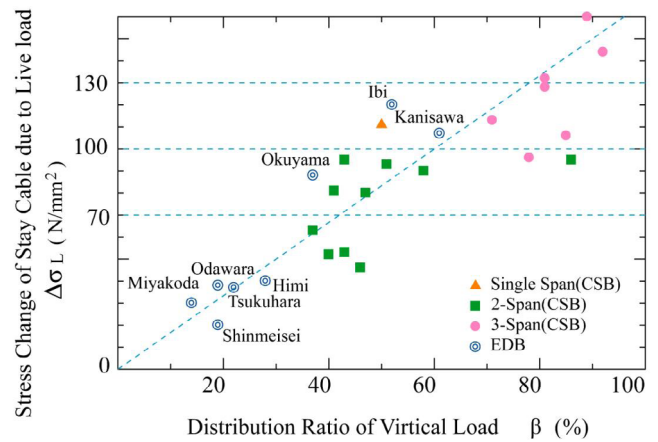

Figure 17. Distribution ratio of vertical load VS stress change due to live load

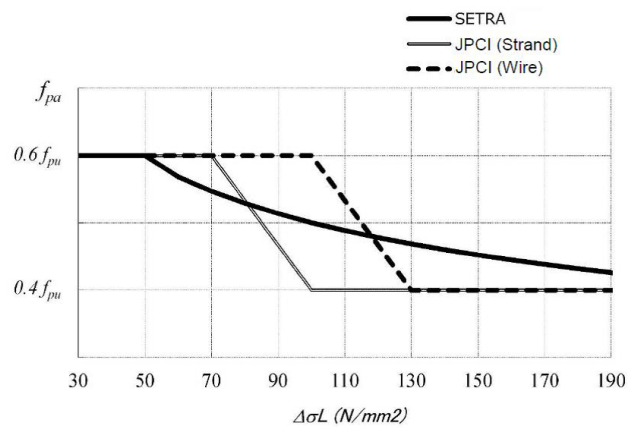

Figure 18. Allowable stress versus stress change owing to live loads by JPCI and SETRA

The first issue is the definition of a cable-stayed bridge and extradosed bridge. The cable-stayed bridge was already covered by current standards, which stipulated an allowable stress for the cables of  $0.4f_{pu}$  in Japan. I decided to think of cable-stayed bridge and extradosed bridge as part of a continuum rather than having a clear borderline between them, and proceeded to investigate and verify the safety factor by focusing on the proportion of live load carried by the cables [10]. Figure 17 shows the results of that investigation. The distribution ratio of vertical load  $\beta$  and the stress change in the stay cables due to live load can be seen to be correlated, which means that the latter can be used as a design parameter. For cable-stayed bridges,  $\beta$  is in the region of 80–100%, as the cables carry nearly all the live load. In contrast, for extradosed bridges,  $\beta$  is in the region of 10–20%, with the main girder carrying most of the live load. There is a clear difference between the two types of bridge, but no clear boundary between them. Consequently, engineers are free to determine the proportions carried by the cables and by the main girder. The concept of the extradosed bridge provides a link between cable-stayed bridges and girder bridges, and is a structural form with a broad range of applicability. Figure 18 shows the standards adopted by JPCI (Japan)

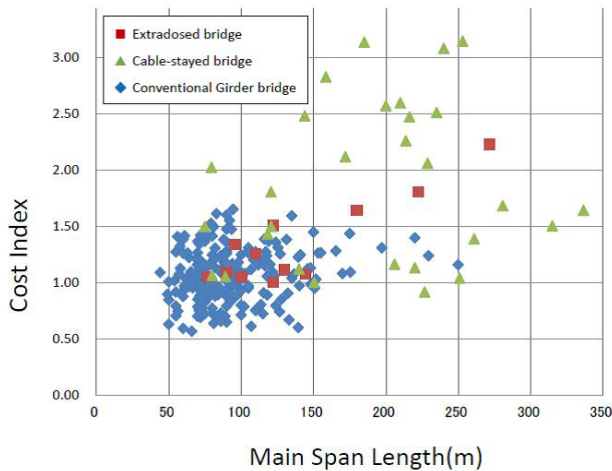

Figure 19. Comparison of cost index in Japan

and SETRA (France). These standards differ as to whether the transition should be straight-line or curved, but the basic approach is the same.

The Japanese standards have one more feature, in that they define the allowable stress in terms of stress variation. This has the advantage of enabling engineers to consider the limit separately for each individual cable. In other words, the allowable stress can differ from cable to cable. Consequently, engineers can assume a low level of allowable stress where there is a large stress variation, or a high level when there is a small stress variation. This permits the adoption of efficient designs that were not possible under conventional standards that determined a single allowable stress for the whole bridge. Furthermore, this design philosophy can be applied to cable-stayed steel bridges as well as to concrete bridges. In each case, what matters is the proportions of live load carried by the cables and the girder. The JPCI standards take the stance that there is no borderline between cable-stayed and extradosed bridges. Today, bridge engineers around the world are increasingly accepting this philosophy.

Another point worth mentioning is the difference in construction cost. Figure 19 shows a comparison of cost index for a number of cable-stayed bridges, girder bridges, and extradosed bridges. The base for the index is the cost for a girder bridge with a 100m span (cost index set to 1.0). Structurally, extradosed bridges fall between girder bridges and cable-stayed bridges, and this chart shows that, broadly speaking, a similar relationship applies to cost considerations. The chart only takes the superstructure into account, so the main factor keeping down the extradosed bridge cost is probably the ability to use lower pylons and simpler cable systems.

## 5. COMPOSITE GIRDER EXTRADOSED BRIDGES

Composite bridges are structures that combine steel and concrete, selecting the material to suit the characteristics required for each part of the bridge. In Japan, where there are frequent earthquakes, reducing girder weight brings a range of bene-

fits, and this has been a driving force behind the remarkable pace of development over the past twenty years. Reducing the weight of the superstructure is the key to innovation in long span bridges supported by cables. The reason is that this approach enables stiffness to be increased without increasing girder weight.

The corrugated steel web bridge dates back to 1965 when Shimada proposed that corrugated steel plate may be used in the web of main girders [11]. However, it was a long time before this marvelous concept was realized in an actual bridge. That was in 1984, when a composite bridge using this approach was completed in France, far away from the birthplace of the idea. By replacing the concrete web with corrugated steel plate, a corrugated steel web bridge enables the weight of the main girder to be reduced by around 10 to 15%. An example of corrugated steel webs used in an extradosed bridge includes the Himi Bridge [12] (Figure 20). The Himi Bridge is particularly interesting as it was the world's first use of a corrugated steel web in a cable supported structure. There are another three examples of corrugated steel web extradosed bridges in Japan.

Moreover, there is one example of the extradosed bridge, the Fudo Bridge, utilizing composite truss techniques but replacing just the web with a steel pipe truss, as can be seen in Figure 21. In addition, as a means of reducing axial forces acting on the truss nodes, it is possible to use a hybrid structure combining a concrete box girder with a space truss as shown in Figure 22.



Figure 20. Himi Bridge



Figure 21. Fudo Bridge



Figure 22. Hybrid combining concrete and space truss

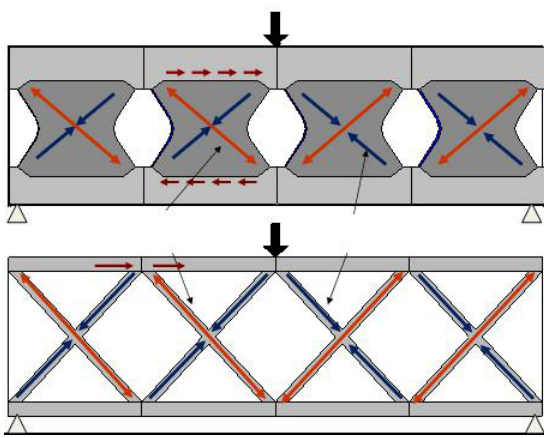

Figure 23. Behavior of butterfly web bridge

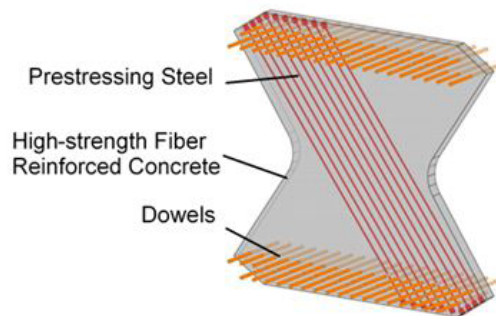

Figure 24. Butterfly web panel

## 6. BUTTERFLY WEB FOR LARGE SPAN EXTRADOSSED BRIDGES

### 6.1 Butterfly web bridge

The butterfly web [13] is a new structure with butterfly-shaped web members having the following characteristics.

- (1) The web is configured with butterfly-shaped panels placed independently and not joined continuously. The shape limits the orientation of compression and tension in the panel due to shear forces, meaning that the structure is similar to a double warren truss (Figure 23).

- (2) The butterfly web uses 80 MPa steel fibre reinforced concrete, and has prestressing steel oriented in the direction that tensile forces act (Figure 24), limiting the occurrence of cracks. It does not use steel reinforcements, relying instead on steel fibers and prestressing to achieve the required strength.
- (3) Transmission of shear forces between the butterfly web and deck slabs is achieved by the joint between the slab concrete and dowels embedded in the panel.

Many corrugated steel web bridges and steel truss web bridges have been built in Japan. These bridges had rational structures and excellent structural characteristics, but at the same time, they required complex machining of steel members, on-site welding, or other special skills for fabrication or construction. In contrast, as the butterfly web is a precast product, all that is needed to construct a girder is to combine the web with the slabs on site. The prestressing steel oriented in the same direction as the tensile forces in the web is pre-tensioned at the factory, so there is no need to work on the butterfly web at the construction site. The potential weight reduction of the main girder is similar to that of a corrugated steel web bridge, achieving about a 10% to 15% reduction compared to a conventional box girder section. Consequently, the length of segments that can be constructed using a form traveler can be 50% longer because of light weight of the girder.

A butterfly web bridge, which uses butterfly-shaped panels instead of a double warren truss, is a new structure that has both the corrugated steel web bridge's advantage of being able to simplify the joints with the concrete slabs, and the truss bridge's advantage of not needing on-site work to make joints between the butterfly-shaped panels that carry the shear forces.

One of these solutions for long span extradosed bridges was used in an innovative project that was completed in 2017. The Mukogawa Bridge, shown in Figure 25 and Figure 26, is an extradosed bridge using butterfly web technology. This is a 5-span continuous rigid frame bridge with a span length of 100 m. The tallest piers are 81.2 m, and they were designed for rapid construction. The cross section incorporates four butterfly webs, and the extradosed cables are located in the center of the cross section. The main girder is constructed by free cantilevering, with individual segments having a length of 6.0 m and incorporating two butterfly web panels parallel to the longitudinal direction. After setting panels, the concrete deck is cast in place. The reduction in superstructure weight achieved enables a substantial reduction in pier thickness and the size of foundations.

### 6.2 Large span extradosed bridge

Conventional explanation of the extradosed bridge used to be that it was a structure that filled the gap between girder bridges and cable-stayed bridges for spans of up to 250 m. However, the use of a butterfly web structure now enables main girder stiffness to be increased without an increase in weight, making it feasible to construct extradosed bridges with span lengths in around 500 m. Moreover, the openings in a butterfly web girder account for 30% of the area of an equivalent full web girder, leading to greater wind stability.





Figure 25. Mukogawa Bridge

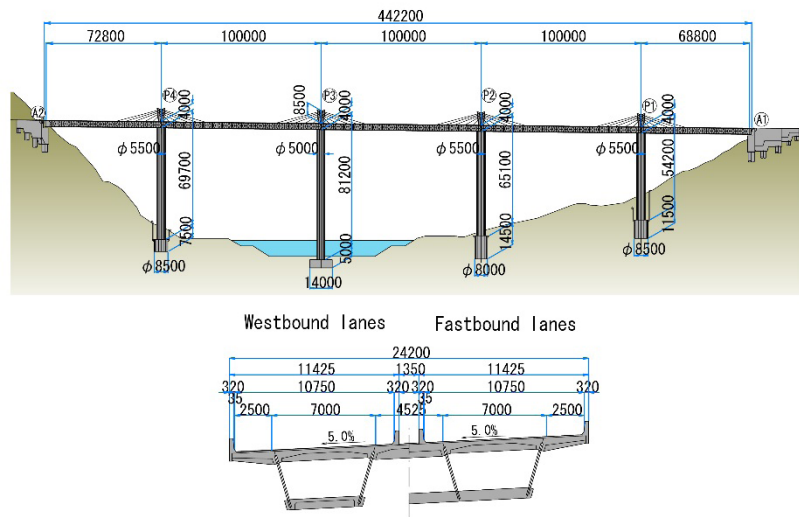

Figure 26. General view of Mukogawa Bridge

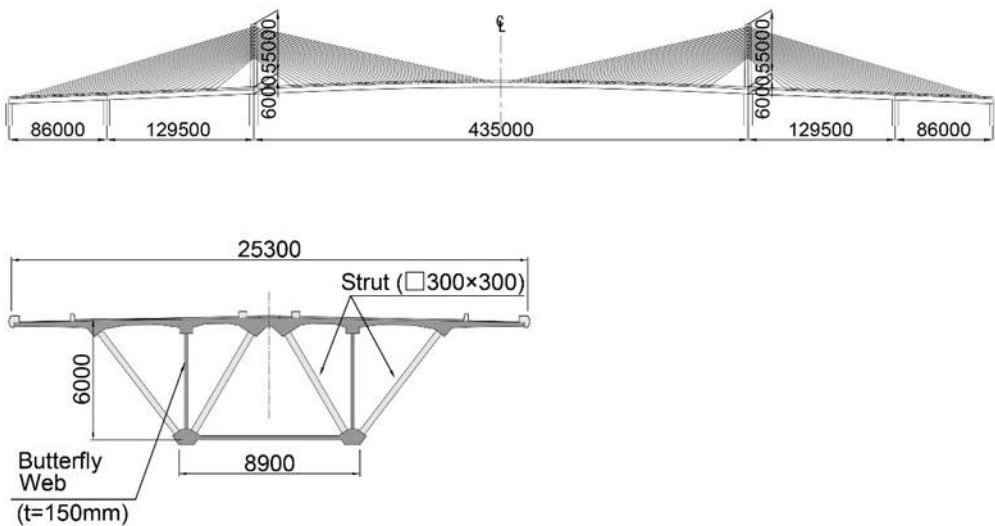
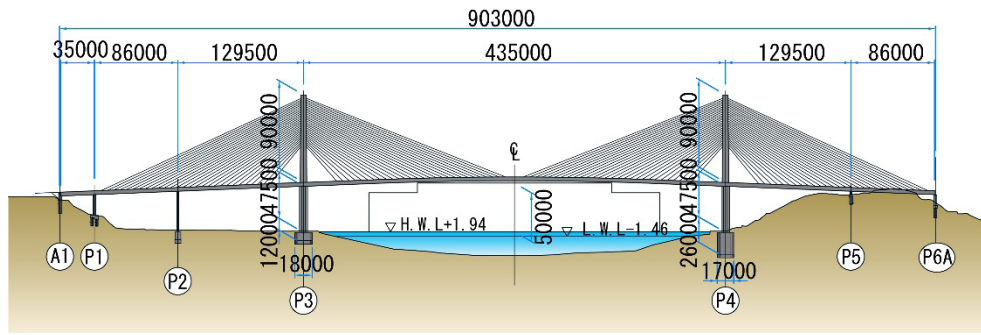
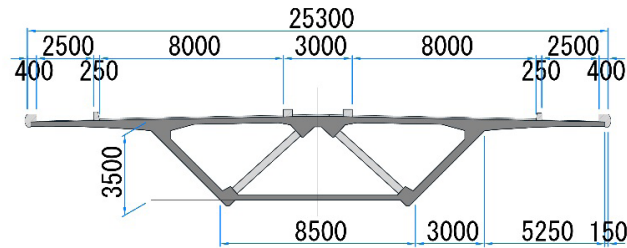

Figure 27. Extradosed Type (a) General view (b) Cross section



(a)



(b)

Figure 28. Cable-stayed type (Bai-Chai Bridge, 2006) (a) General view (b) Cross section

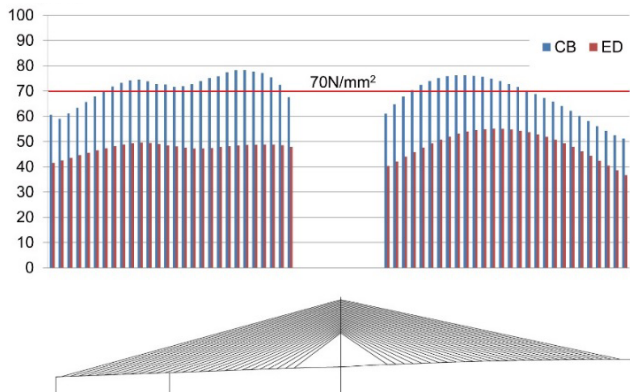

Figure 29. Stay cable stress change due to live load

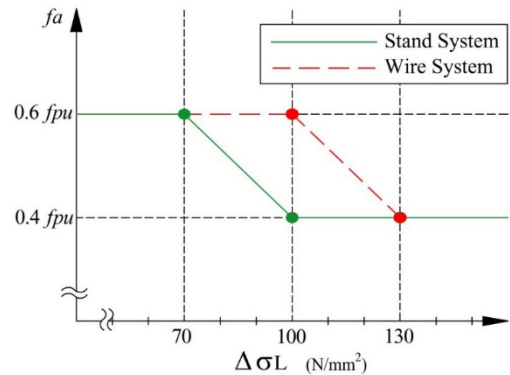

Figure 30. Allowable stay cable stress VS stress change owing to live loads

An extradosed bridge with a central span of 435 m as shown in Figure 27 [14] is considered, and it has lower pylons, about 60% of the height of the towers for the cable-stayed bridge, Bai-Chai Bridge (Figure 28). The girder height is 6.0 m in the extradosed type, using a single plane of stay cables and struts inside the box girder. The extradosed bridge uses a butterfly web to counter the increase in weight due to the larger girder height. Consequently, the superstructure weight is unchanged compared with conventional cable-stayed bridges, but the stiffness of the main girder is doubled. Figure 29 shows the variation in stay tension due to live loads. The JPCI standards in Japan (Figure 30) permit a maximum allowable stress of  $0.6f_{pu}$  for stay cables, even for this sort of long span extradosed bridge. The number of cables required is about 20% more than for the cable-stayed bridge, but because the weight reduction technology has produced a stiffer main girder without an increase in weight, the pylons can be shorter, which

makes this structure very competitive in earthquake-prone Japan. Table 1 shows a comparison of the material quantities for the two configurations. The amount of concrete for the extradosed bridge using butterfly webs is almost the same, despite having a deeper girder. And because the safety factor can be lowered with the use of an extradosed bridge, the weight of stay cables is similar to that of the cable-stayed bridge, even with a shorter pylons. This

TABLE 1  
Comparison of material quantities (Three spans).

			CB	ED
Concrete	Girder	m <sup>3</sup>	13200	13400
	Tower	m <sup>3</sup>	2200	1400
Rebar		ton	3190	2751
Prestressing steel		ton	220	195
Stay cable		ton	1040	1042

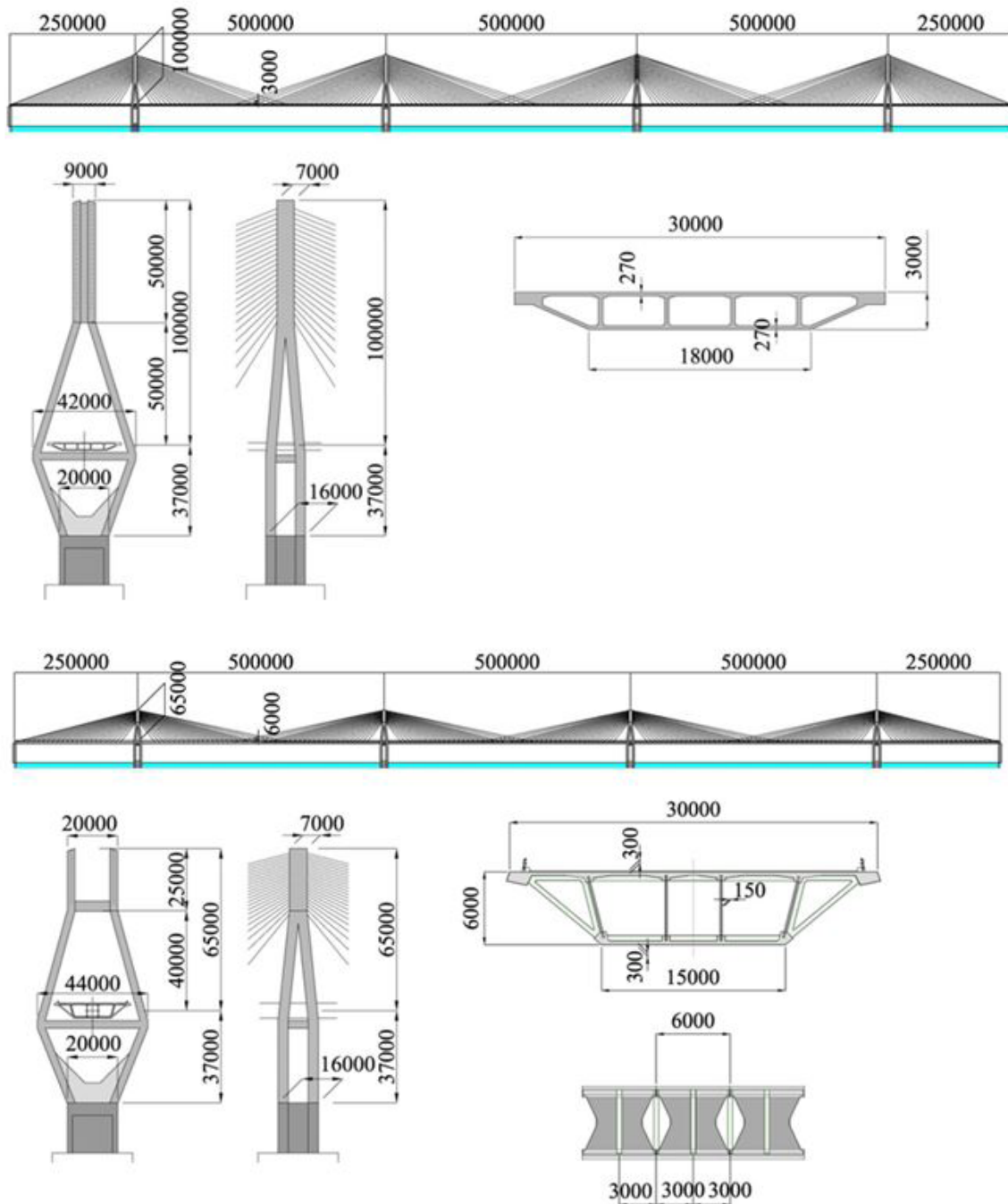

Figure 31. 500-m Five-span bridge. (a) Cable-stayed type and (b) Extradosed type

demonstrates that a long span extradosed bridge with reduced weight main girder is feasible.

### 6.3 Multi-span large extradosed bridge

The benefits of butterfly web are particularly clear with long span multi-span bridges, which tend to have a lower overall stiffness. Increasing the stiffness of the main girder enables the bridge to be designed with lower pylons, enhancing seismic performance and suppressing cable stress variation.

The models used for this comparative study are a cable-stayed bridge and an extradosed bridge composed of five

continuous spans with a central span of 500 m (Figure 31). In order to raise the overall stiffness of the multi-span cable supported structure, overlapping cables are distributed at the middle of the span, and the stiffness of the bridge piers and pylons is increased. Moreover, highly stiff butterfly webs with a 6.0 m depth are used for the extradosed bridge. Using these two structures, stay cable stress variations at the serviceability limit state was compared, and the structural feasibility of the proposed continuous long span extradosed bridge is verified [15].

Figure 32 shows a comparison of the stress variations in stay cables due to live loads. According to the JPCI standards (Figure 30), up to  $0.6f_{pu}$ , the limit value for stay cable tension,

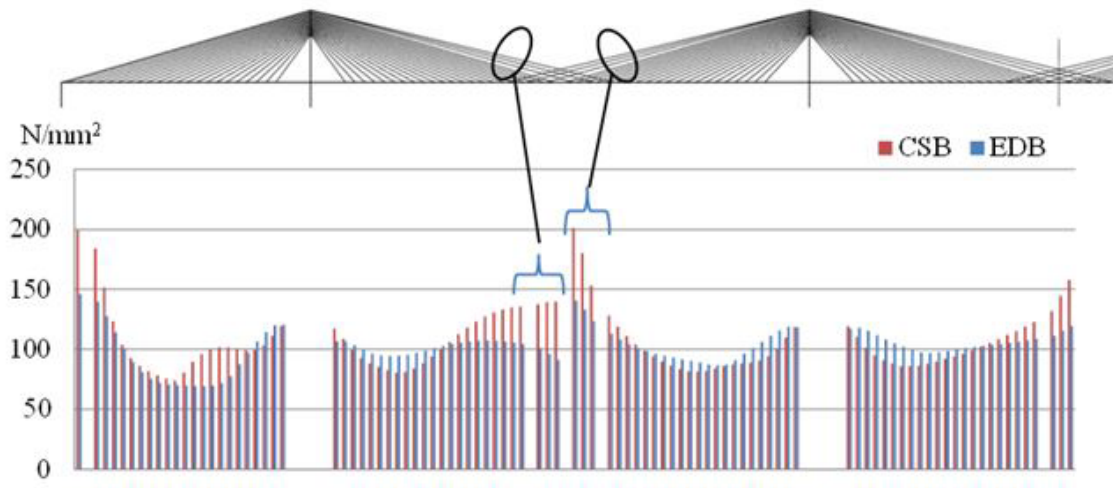

Figure 32. Stay cable stress variations owing to live loads

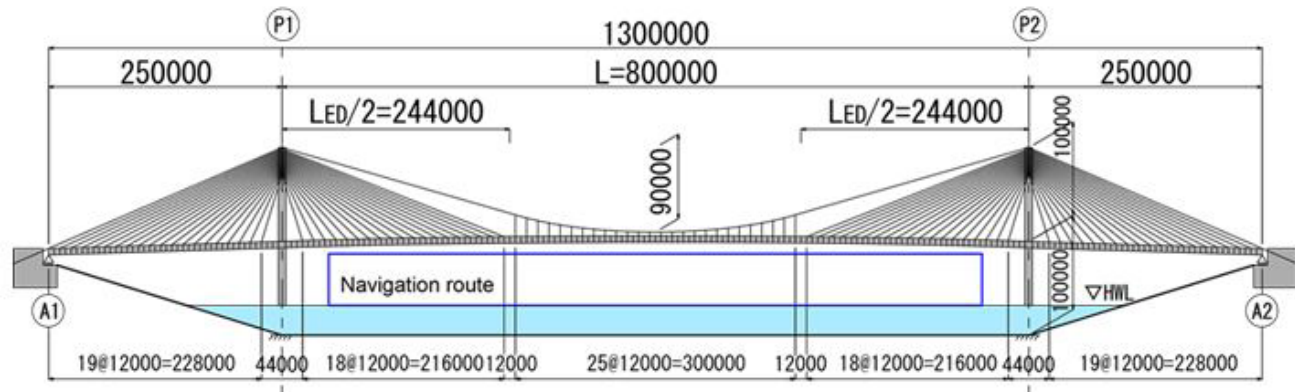

Figure 33. Hybrid of extradosed and suspension bridge with 800m span

is allowed for road bridges as long as the stay cable stress variation is 70 N/mm<sup>2</sup> or less. However, it was confirmed that almost all of the cable stress variation exceeds 70 N/mm<sup>2</sup> except some cables of the side span because multi-span structures are very flexible. Table 2 shows a comparison of the material quantities for the two configurations. The amount of concrete for the extradosed bridge using butterfly webs is lighter, despite having a deeper girder. Moreover, the material required for the pylons was reduced. However, there is no big difference of the weight of stay cables in the multi-span structures.

#### 6.4 Large span hybrid design for future generations of bridges

The first idea of hybrid structure in the Brooklyn Bridge which combines the suspension system with the stays to achieve more efficient structural system has been noticed [16]. However, these hybrid structures are generally adopted with higher towers, in stress which consequently, the angular change of the main suspension cable at the tower saddle could be larger and

causes increasing secondary stresses in the main cable to lead the cable becomes more critical in fatigue.

Therefore, to deal with the secondary stresses in main suspension cable and as well as to enhance the aerodynamic stability of the hybrid structure, we aim to develop a long span concrete box girder bridge which is a hybrid between an extradosed structure and a suspension structure. By using a deeper girder, the hybrid structure is expected to be stiffer and at the same time, the angular change of the main suspension cable will be smaller due to their short towers.

Furthermore, in order to reduce the weight of the girder,

TABLE 2 Comparison of material quantities (Five spans).

			CB	ED
Concrete	Girder	m <sup>3</sup>	48900	43700
	Pylon	m <sup>3</sup>	18500	1400
Rebar		ton	15960	2751
Prestressing steel		ton	259	261
Stay cable		ton	6030	6300



Figure 34. 800m span hybrid bridge

the butterfly web girder in which the webs were replaced by thin panels with a butterfly-wing shaped was adopted. In past studies, butterfly web has an open section of around 30% and can reduce the weight of the superstructure from 10% to 20%. It is also expected that its wind resistance is appropriate, due to its special openings, and maintenance is easier because of brightness in the girder.

As a case study, a hybrid of extradosed and suspension bridge with 800 m span of concrete butterfly web girder was suggested (Figure 33) [17]. The bridge basically consists of a main span 800 m long and effective width of 30 m respectively. Stiffening girder is a structural element subjected directly to the live load and transfer the vertical load globally to the main tower through the cable system. For the extradosed bridge, by making the girder deeper, the stiffness of the girder increases so that the load distribution ratio for the cable is smaller and makes the material consumption effectively. The towers are considered to be 100 m in height as well as the girder is set to 7 m deep with 150 mm butterfly web.

In a hybrid structure system, some important issues have been raised, such as the discontinuity of the system and how to optimize the span of the extradosed area to achieve an economical efficiency as well. The hybrid systems with three different extradosed-to-span ratios, 79%, 61% and 43% respectively, are examined and investigated their structural behaviors. Herein, the extradosed-to-span ratio is the ratio of extradosed span ( $L_{ED}$ ) to main span ( $L$ ). After a parametric study, it was confirmed that this new type structure of hybrid bridge was able to be soundly designed. Moreover, it was found that the system with extradosed-to-span ratio of 61% used the least materials than the others (Figure 34).

## 7

### CONCLUSIONS

When the construction of the Odawara Blueway Bridge was reported in the *Engineering News Record*, using the unfamiliar term “extradosed” coined by a French engineer, one editor jokingly asked in its editorials if regular cables would now have to be called “intradosed” [18]. Now, however, extradosed bridges have become so familiar to the community that no-one makes such comments any more. I am delighted that extradosed bridges have progressed to such an extent. My only regret is that I was unable to meet Jacques Mathivat before he passed away in 2012. There are lots of questions that I wanted to ask

him about the structural form that he introduced, and I would have been very keen to hear his thoughts on the projects that I have been involved in.

My story of the extradosed bridge began with Mathivat’s theory and the Odawara Blueway Bridge. I have now been involved with extradosed bridges for a substantial proportion of my career as a bridge engineer, and have always felt a close affinity for the structure as it took form and developed. And it is a great satisfaction to have been able to propose an evolution that addresses the challenge of longer spans, further extending the applicability of the extradosed bridge.

Just as partially prestressed concrete concept acts as a link between reinforced concrete and prestressed concrete, the extradosed bridge has linked the cable-stayed bridge and the girder bridge. In doing so, it has greatly expanded the degree of freedom available for designs. That sense of freedom is surely one of the reasons why bridge engineers around the world continue to construct extradosed bridges.

### References

- [1] Mathivat, J. Recent Development in Prestressed Concrete Bridges. *FIP notes*: pp15-21. 1988/2.
- [2] Kimizu, T, et al, Research on Saddle System of Odawara Blueway Bridge, Prestressed Concrete, JPCA, 1994. (in Japanese)
- [3] Kasuga, A, et al. Testing of High Damping Rubber Damper for Stay Cables, EASEC-5, Australia, pp243-246, 1995
- [4] Onodera, I, et al, Bending Fatigue Test for Stay Cable System of Odawara Blueway Bridge, JPCA Symposium 1995. (in Japanese)
- [5] Fujita, M, et al, Fretting Fatigue Characteristics in the Curved Layout of Large-capacity Prestressing Strands, 15th US-Japan Bridge Engineering Workshop, Tsukuba, 1999
- [6] JPCI. November 2000. *Specifications for design and construction of prestressed concrete cable-stayed bridges and extradosed bridges*: Japan Prestressed Concrete Institute.
- [7] <https://www.dywidag-systems.com/emea/products/stay-cable-systems/dynar-link-anchor-box-system.html>
- [8] <http://www.vsl.com/business-lines/systems-and-technologies/stay-cable-systems.html>
- [9] Schlaich, M, Abdalsamad, A, Annan, R, Fatigue and Tensile Tests of a 55 Strands Saddle System, *Proceedings of 3rd fib International Congress 2010, Washington DC*.
- [10] Ogawa, A, Kasuga, A, Extradosed Bridges in Japan, *FIP Note*, pp11-15, 1998/2.
- [11] Shimada S. Dec. 1965. Shear Strength of Steel Plate Girders with Folded Web Plate (Ripple Web Girders). *Journals of the Japan Society of Civil Engineers* No.124: 1-10. (in Japanese)
- [12] Maeda Y., et al. 2002. Design and Construction of the Himi Bridge – Extradosed Bridge with Corrugated Steel Web. 1st fib Congress 2002 Session1: 95-100. Osaka
- [13] Kasuga, A., et al. 2010. Study of a bridge with a new structural system using ultra high strength fiber reinforced concrete. *Proceedings of 3rd fib Congress*: Washington DC.
- [14] Kasuga, A., et al. 2015. Study on 500m span extradosed bridges. *fib Symposium Copenhagen*.
- [15] Kasuga, A. Multi-span extradosed bridge, *Multi-Span Large Bridge*, pp67-82, 2015.
- [16] Gimsing, N. J. et al. 2012, *Cable supported bridges*, John-Wiley, West Sussex, UK.
- [17] Salpisoth, H. et al. 2017, Study on the design of an extradosed and suspension hybrid bridge with 800m span of butterfly web girder, *fib Symposium, Maastricht*.
- [18] *Engineering News Record*, McGraw-Hill Construction Weekly, p90, February 21, 1994.